

DMSTEX Business Solutions

DDGS Presentation 3

Generated Data Handling

Sponsored by DMSTEX Business Solutions

- Founded 2010
- 25 Years Oracle Experience
- Database Design and Generation Service
 - Oracle Database Schema
 - PL/SQL Application Programming Interfaces
 - Application Specific Test Data
 - APEX Data Maintenance Forms

Oracle and Java are registered trademarks of Oracle Corporation and/or its affiliates.

Database Design and Generation Service (DDGS) Presentations

A Series of 5 Presentations

1. DDGS Deliverables
2. DDGS Generated API
3. **DDGS Generated Data Handling**
4. DDGS Generated Subtypes
5. DDGS Generated History and Audit

Presentations do not cover all functionality

3. DDGS Generated Data Handling

- Documentation and Setup (2 slides)
- Case Folding
- White Space Reduction
- PATH Hierarchies
- Quantized Date/Time
- XML
- BLOB/APEX_FILE
- GeoLocation

Documentation

E-R Diagram

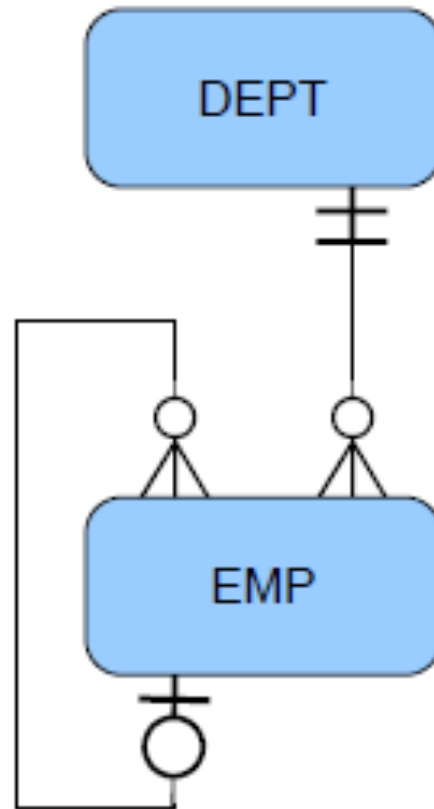

Setup

- Text Editor
- Command Prompt
- Oracle Database 11g
- P3 Deliverables
- Web Browser
- Adobe Reader

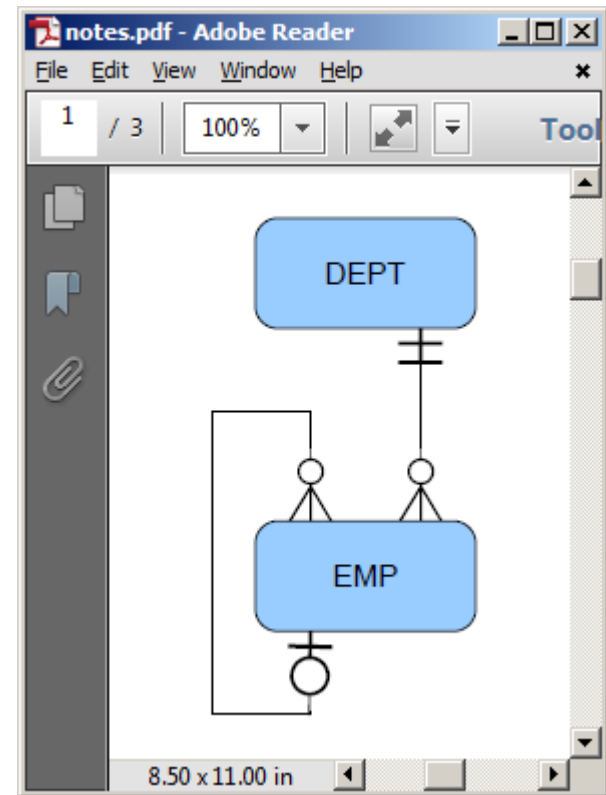

3. DDGS Generated Data Handling

- Documentation and Setup
- Case Folding (2 slides)
- White Space Reduction
- PATH Hierarchies
- Quantized Date/Time
- XML
- BLOB/APEX_FILE
- GeoLocation

Case Folding

```
SQL> insert into emp (ename, job, mgr_emp_id,  
2      hiredate, sal, dept_id)  
3          values ('Duane', 'CLERK', -7788,  
4      '01-JUL-10', 100, -20);
```

1 row created.

```
SQL> select id, ename, job, mgr_emp_id, dept_id  
2      from emp where ename = 'DUANE';
```

ID	ENAME	JOB	MGR_EMP_ID	DEPT_ID
1	DUANE	CLERK	-7788	-20

```
SQL> commit;
```

Commit complete.

Case Folding

Column Name	NK	REQ	FLD	WSR	Default
-----	--	---	---	---	-----
id		X			emp_SEQ.
nextval					
ename	1		U	X	
job		X			
-- Domain: P3, JOB					
mgr_emp_id					
-- Foreign Key: mgr_ID_PATH, mgr_NK_PATH, mgr_emp_nk1					
hiredate		X			
-- DATE Truncate every 1 Days of the Month					
sal		X			
comm					
dept_id		X			
-- Foreign Key: dept_nk1					

3. DDGS Generated Data Handling

- Documentation and Setup
- Case Folding
- White Space Reduction (2 slides)
- PATH Hierarchies
- Quantized Date/Time
- XML
- BLOB/APEX_FILE
- GeoLocation

White Space Reduction

The screenshot shows a web browser window with the title 'Emp Form'. The address bar contains the URL '127.0.0.1:8080/apex/f?p=203:1220:3068072034012909'. The page displays a navigation menu with 'Dept Form' and 'Emp Form' (highlighted in red). Below the menu is a breadcrumb trail: 'Home > Maintenance Menu > Emp Maint > Emp Form'. The main form area has a title bar with 'Emp Form', 'Cancel', and 'Create' buttons. The form fields are:

- Id:** (empty)
- Ename:**
- Job:**
- Mgr Emp Id:**
- Mgr Id Path:**
- Mgr Nk Path:**
- Mgr Emp Nk1:**

White Space Reduction

The screenshot shows a web browser window with the title 'Emp Form'. The address bar contains the URL '127.0.0.1:8080/apex/f?p=203:1220:1098495515502183:'. The page header includes 'Welcome: P3_USR Logout'. Below the header is a navigation bar with 'Dept Form' and 'Emp Form' (highlighted in red). A breadcrumb trail shows 'Home > Maintenance Menu > Emp Maint > Emp Form'. A toolbar contains buttons for 'Emp Form', 'Cancel', 'Delete', 'Apply Changes', and 'Cancel Changes and Create NEW Record'. The form fields are as follows:

Id:	2
Ename:	<input type="text" value="NEW EMPLOYEE"/>
Job:	<input type="text" value="ANALYST - Systems Analyst"/>
Mgr Emp Id:	<input type="text" value="-7566"/>
Mgr Id Path:	<input type="text" value="-7839:-7566"/>
Mgr Nk Path:	<input type="text" value="KING:JONES"/>
Mgr Emp Nk1:	<input type="text" value="JONES"/>

3. DDGS Generated Data Handling

- Case Folding
- White Space Reduction
- PATH Hierarchies
- Quantized Date/Time
- XML
- BLOB/APEX_FILE
- GeoLocation

White Space Reduction

Emp Form

127.0.0.1:8080/apex/f?p=203:1220:1098495515502183:☆

Welcome: P3_USR Logout

Dept Form **Emp Form**

Home > Maintenance Menu > Emp Maint > Emp Form

Emp Form Cancel Delete Apply Changes Cancel Changes and Create NEW Record

Id: 2

Ename:

Job:

Mgr Emp Id:

Mgr Id Path:

Mgr Nk Path:

Mgr Emp Nk1:

Path Hierarchies

The screenshot shows a web browser window with the title "Emp Form". The address bar contains the URL "127.0.0.1:8080/apex/f?p=203:1220:1098495515502183:". The page displays a navigation menu with "Dept Form" and "Emp Form" (highlighted in red). Below the menu is a breadcrumb trail: "Home > Maintenance Menu > Emp Maint > Emp Form". A toolbar contains buttons for "Emp Form", "Cancel", "Delete", "Apply Changes", and "Cancel Changes and Create NEW Record". The main form area contains the following fields:

- Id: 2
- Ename: NEW EMPLOYEE
- Job: ANALYST - Systems Analyst
- Mgr Emp Id: -7521
- Mgr Id Path: -7839:-7698:-7521
- Mgr Nk Path: KING:BLAKE:ALLEN
- Mgr Emp Nk1: ALLEN

3. DDGS Generated Data Handling

- Documentation and Setup
- Case Folding
- White Space Reduction
- PATH Hierarchies
- Quantized Date/Time
- XML
- BLOB/APEX_FILE
- GeoLocation

Quantized Date/Time

```
SQL> select to_char(hiredate, 'DD-Mon-YYYY HH24:MI:SS')
       2   from emp where ename = 'KING';
```

```
TO_CHAR(HIREDATE, 'DD-MON-YYYY
```

```
-----
```

```
17-Nov-1981 00:00:00
```

```
SQL> update emp set hiredate = to_date('18-Nov-1981 14:21:
30',
```

```
       2   'DD-Mon-YYYY HH24:MI:SS') where ename = 'KING';
```

```
1 row updated.
```

```
SQL> select to_char(hiredate, 'DD-Mon-YYYY HH24:MI:SS')
```

```
       2   from emp where ename = 'KING';
```

```
TO_CHAR(HIREDATE, 'DD-MON-YYYY
```

```
-----
```

```
18-Nov-1981 00:00:00
```

3. DDGS Generated Data Handling

- Documentation and Setup
- Case Folding
- White Space Reduction
- PATH Hierarchies
- Quantized Date/Time
- XML (3 slides)
- BLOB/APEX_FILE
- GeoLocation

XML



Emp Maint

127.0.0.1:8080/apex/f?p=102:1020:44398023782550

Ename	FORD
Job	ANALYST
Mgr Emp Id	-7566
Mgr Id Path	-7839:-7566
Mgr Nk Path	KING:JONES
Mgr Emp Nk1	JONES
Hiredate	03-DEC-81
Sal	3000
Comm	-
Dept Id	-20
Dept Nk1	RESEARCH
Resume	Download

History Preview

```
<?xml version="1.0"?>
<emphist>
  <emp>
    <seq>1</seq>
    <name>AXME Anvils</name>
    <city>Detroit</city>
    <state>MI</state>
    <from>01-JAN-2001</from>
    <to>01-JAN-2002</to>
  </emp>
</e
```

XML

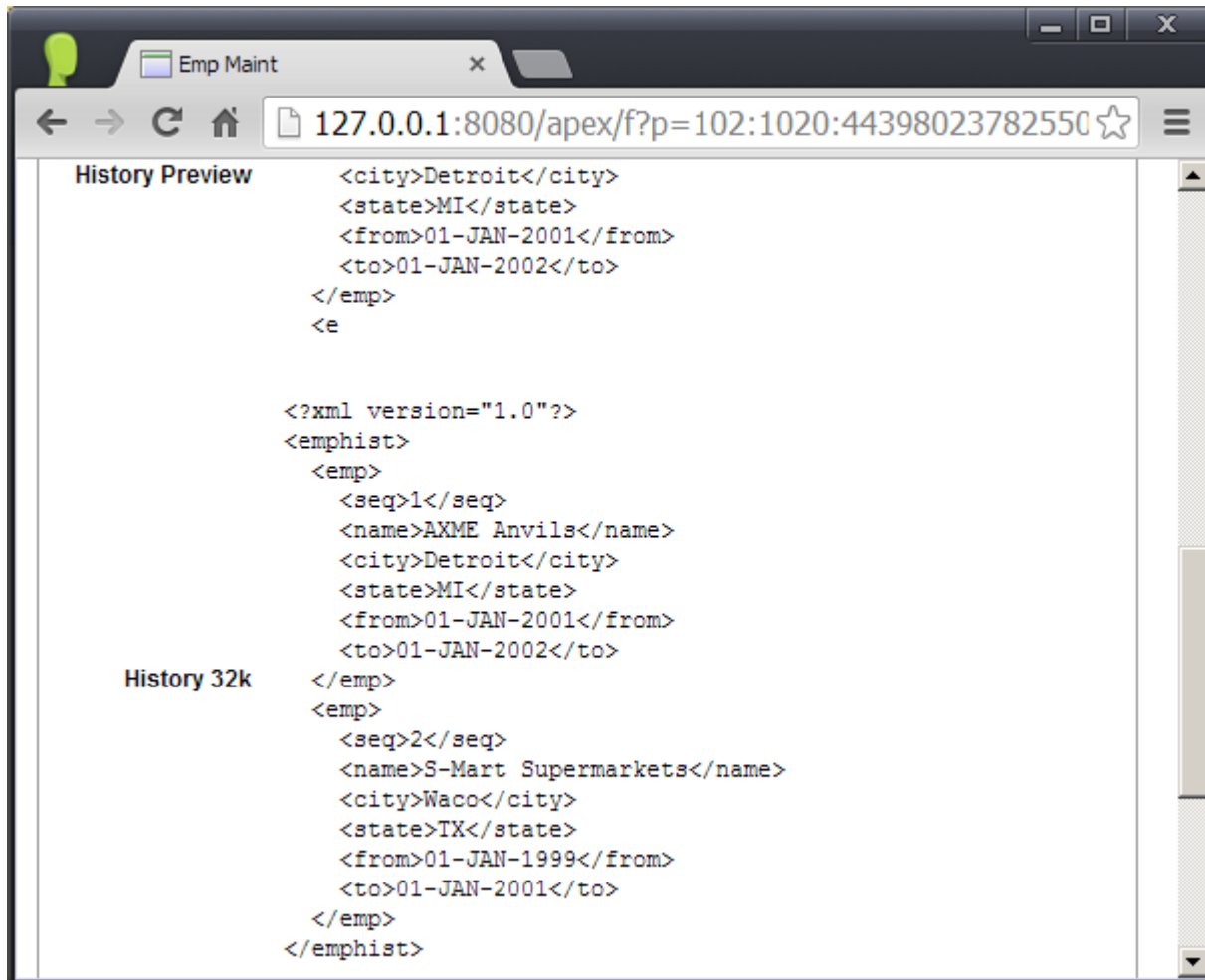

The screenshot shows a web browser window with a single tab titled 'Emp Maint'. The address bar contains the URL '127.0.0.1:8080/apex/f?p=102:1020:44398023782550'. The main content area displays XML data under the heading 'History Preview'. The XML is partially truncated, showing the end of one element and the beginning of another. The visible XML code is as follows:

```
<city>Detroit</city>
<state>MI</state>
<from>01-JAN-2001</from>
<to>01-JAN-2002</to>
</emp>
<e

<?xml version="1.0"?>
<emphist>
  <emp>
    <seq>1</seq>
    <name>AXME Anvils</name>
    <city>Detroit</city>
    <state>MI</state>
    <from>01-JAN-2001</from>
    <to>01-JAN-2002</to>
  </emp>
  <emp>
    <seq>2</seq>
    <name>S-Mart Supermarkets</name>
    <city>Waco</city>
    <state>TX</state>
    <from>01-JAN-1999</from>
    <to>01-JAN-2001</to>
  </emp>
</emphist>
```

XML

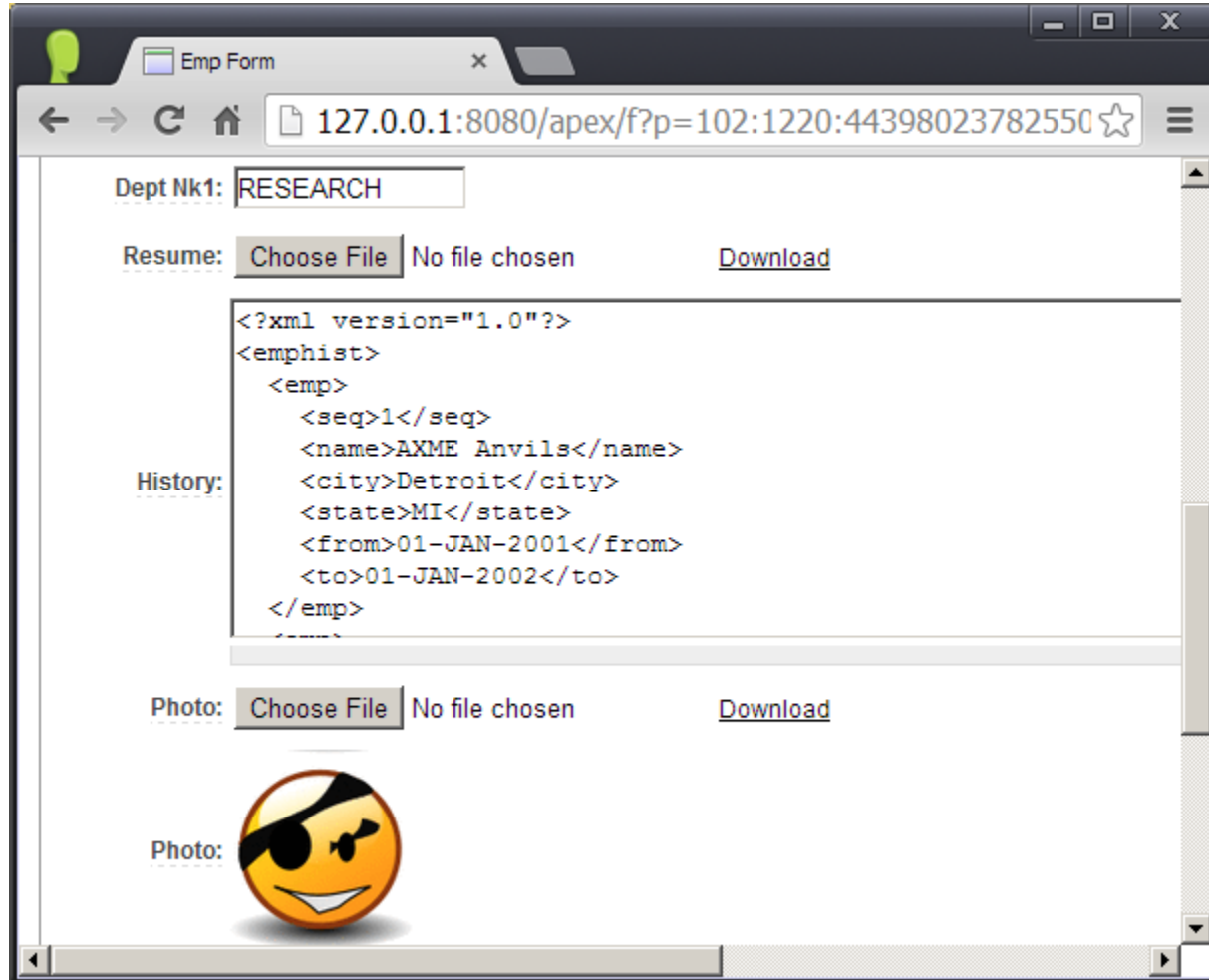

The screenshot shows a web browser window with the title "Emp Form". The address bar displays the URL "127.0.0.1:8080/apex/f?p=102:1220:44398023782550". The page contains several form fields:

- Dept Nk1:** A text input field containing the value "RESEARCH".
- Resume:** A file upload section with a "Choose File" button, the text "No file chosen", and a "Download" link.
- History:** A text area containing the following XML code:

```
<?xml version="1.0"?>
<emphist>
  <emp>
    <seq>1</seq>
    <name>AXME Anvils</name>
    <city>Detroit</city>
    <state>MI</state>
    <from>01-JAN-2001</from>
    <to>01-JAN-2002</to>
  </emp>
```
- Photo:** A file upload section with a "Choose File" button, the text "No file chosen", and a "Download" link.
- Photo:** A field containing a "Smiling Face with Smiling Eyes" emoji (😄).

3. DDGS Generated Data Handling

- Documentation and Setup
- Case Folding
- White Space Reduction
- PATH Hierarchies
- Quantized Date/Time
- XML
- BLOB/APEX_FILE (3 slides)
- GeoLocation

BLOB / APEX_FILE

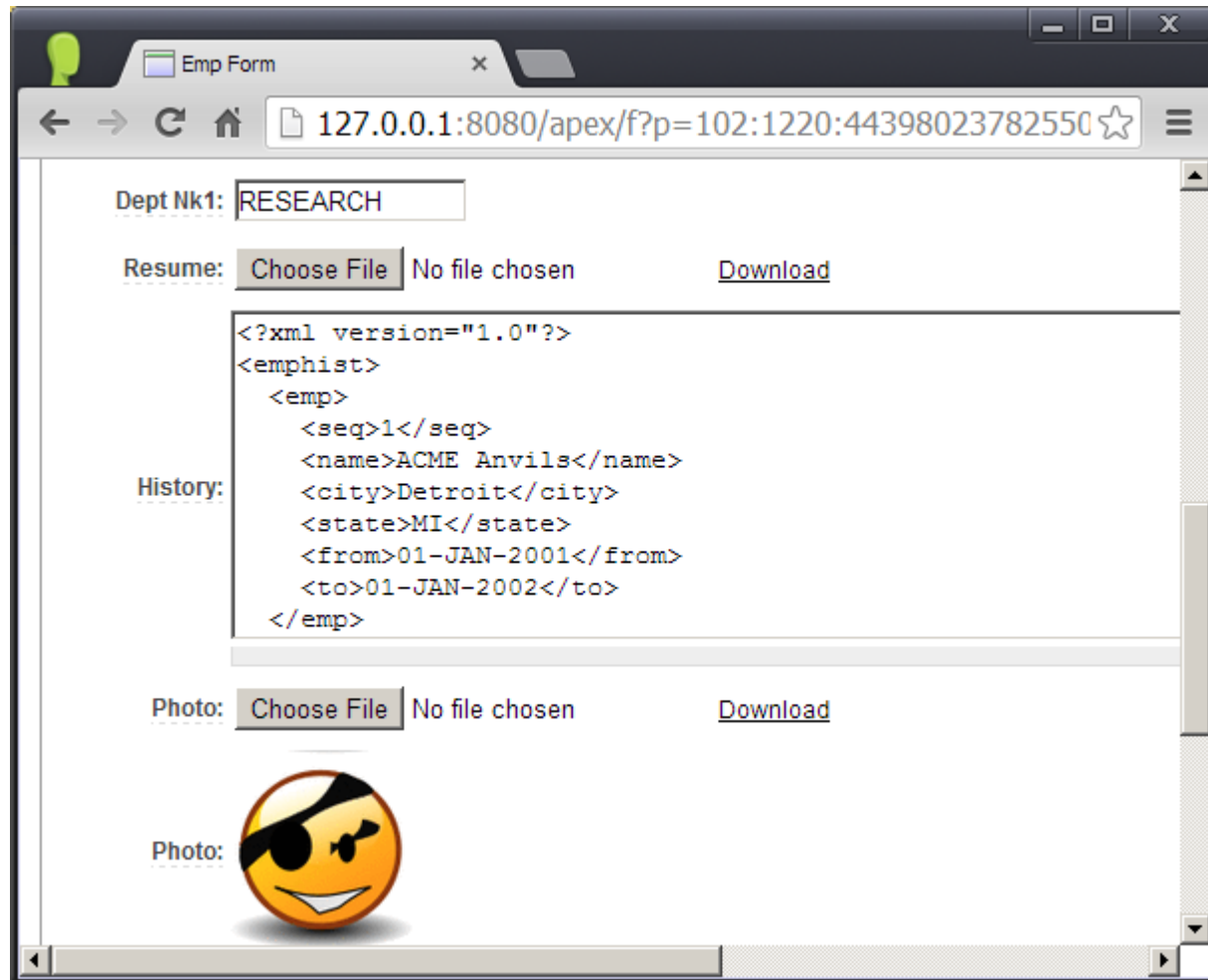

BLOB / APEX_FILE

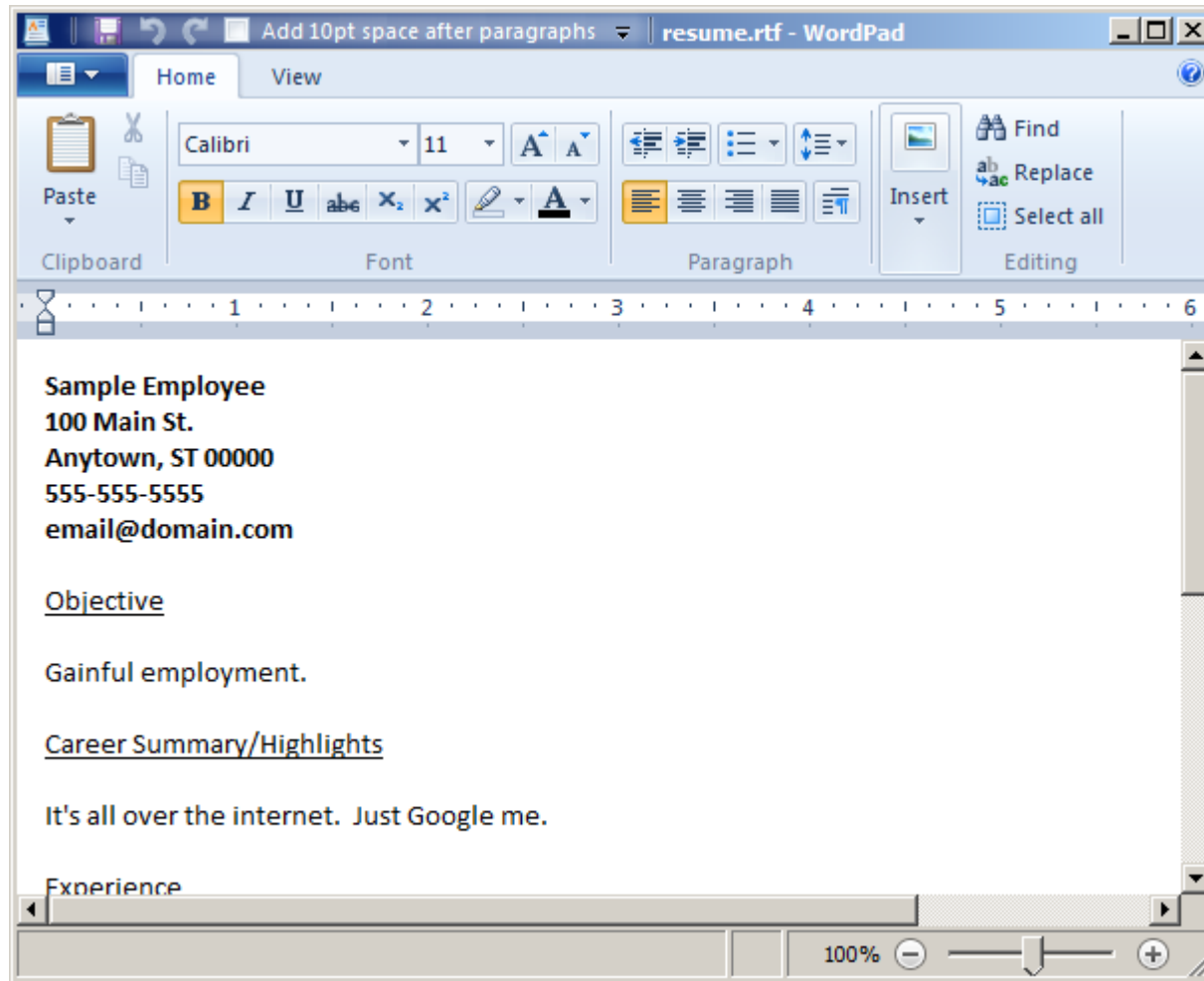

BLOB / APEX_FILE

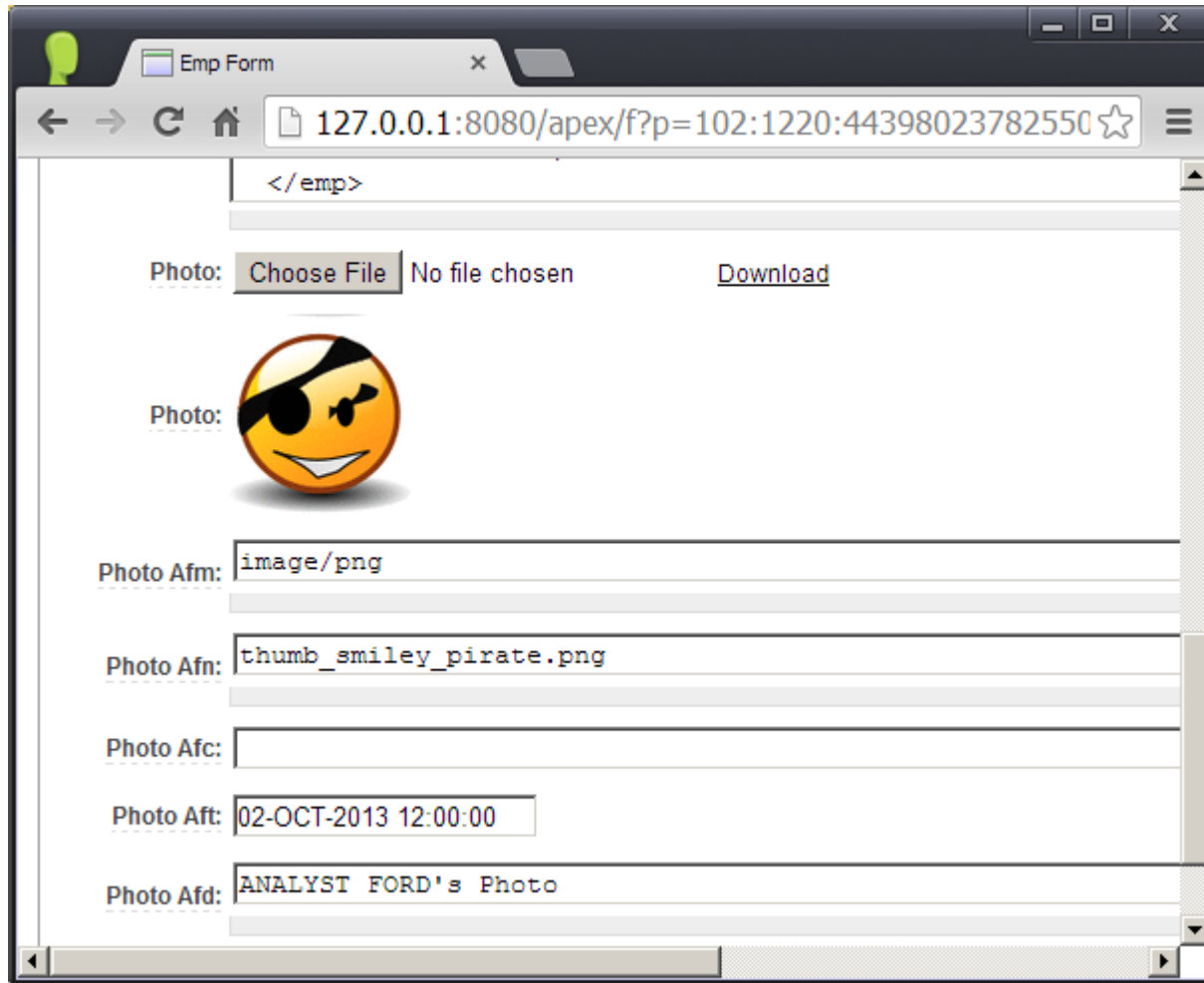

3. DDGS Generated Data Handling

- Documentation and Setup
- Case Folding
- White Space Reduction
- PATH Hierarchies
- Quantized Date/Time
- XML
- BLOB/APEX_FILE
- GeoLocation (2 slides)

GeoLocation

The screenshot shows a web browser window with the title 'Dept Form'. The address bar contains the URL '127.0.0.1:8080/apex/f?p=203:1210:1098495515502183:☆'. The page header includes 'Welcome: P3_USR' and a 'Logout' link. Below the header, there are two tabs: 'Dept Form' (active) and 'Emp Form'. A breadcrumb trail shows 'Home > Maintenance Menu > Dept Maint > Dept Form'. A toolbar contains buttons for 'Dept Form', 'Cancel', 'Delete', 'Apply Changes', and 'Cancel Changes and Create NEW Record'. The main form area displays the following data:

Id:	-20
Dname:	RESEARCH
Loc:	DALLAS
Geo Loc Xcrd:	-96.796667
Geo Loc Ycrd:	32.775833
Geo Loc Srid:	8307

GeoLocation

Welcome: P3_USR Logout

Maintenance Menu Utility Log Report OMNI Reports Menu ASOF Reports Menu

Home > GEO Reference Report

GEO Reference Report

Q- Go Rows 15 Actions

Row text contains '8307'

Reference Id	Reference Name	Reference Attributes	Reference Source
8307	Longitude / Latitude (WGS 84)	Ellipsoidal 2D CS. Axes: latitude, longitude. Orientations: north, east. UoM: dec deg	- Oracle

1 - 1

3. DDGS Generated Data Handling

- Documentation and Setup
- Case Folding
- White Space Reduction
- PATH Hierarchies
- Quantized Date/Time
- XML
- BLOB/APEX_FILE
- GeoLocation

<http://www.dmstex.com>